



AENSI Journals

## Advances in Environmental Biology

ISSN-1995-0756 EISSN-1998-1066

Journal home page: <http://www.aensiweb.com/AEB/>

### Designing Constructive Systems Based on the Spine Structure

<sup>1</sup>Neda Salsabili, <sup>2</sup>Dr. Mohammad Mahdi Mahmoudi, <sup>3</sup>Dr. Nasser Salsabili, <sup>4</sup>Alireza Nasr Azadani

<sup>1</sup>MA in Architectural Technology, School of Architecture, College of Fine Arts, Tehran, IRAN

<sup>2</sup>Assistant Professor of Architecture School of Architecture, College of Fine Arts, Tehran, IRAN

<sup>3</sup>Professor of Rehabilitation, School of Rehabilitation, Tehran, IRAN

<sup>4</sup>MA of Industrial Design, College of Fine Arts, School of Visual Arts, Tehran, IRAN

#### ARTICLE INFO

##### Article history:

Received 25 June 2014

Received in revised form

8 July 2014

Accepted 14 October 2014

Available online 16 November 2014

##### Keywords:

Bionics, Bionic architecture, The Spine, Inter-vertebral Structure

#### ABSTRACT

**Background:** Bionics or bionic architecture is a science which draws the technical inspiration of buildings and constructions from diverse behavior and connections of the living creatures' world and resolves technical issues in biological ways. **Objective:** Bionics was first introduced in the 1950s and is seen in a lot of works done in different sciences. Nowadays, bionic architecture as a sub-set of this science has been recognized as one of the three world's supreme sciences and this shows that what we had as architecture before has created some tensions in today's human life and architecture has lost its original and fundamental base (the nature). **Results:** In fact, it is time to reconsider the nature and to stand up and do something in return for the compensation of all our historic negligence in this regard. Indeed, bionic architecture is the product of 3 main elements: structure, mechanism, and form. What we have now in architecture is only the application of mechanism and form rather than structure. There are a lot of researches and studies on living creatures especially humans that have not been considered yet. **Conclusion:** On the first sight, it may be assumed that human's body is very complicated, but by studying it we come to this conclusion that it has a very comprehensible and applicable structure contrary to our assumption. In the present study, it is attempted to design an appropriate structure system by studying spine's kinesiology and understanding all the connections among its components so that the structural system can perform a lot of diverse actions and can keep its balance all the time just like the spine.

© 2014 AENSI Publisher All rights reserved.

**To Cite This Article:** Neda Salsabili, Dr. Mohammad Mahdi Mahmoudi, Dr. Nasser Salsabili, 4Alireza Nasr Azadani, Designing Constructive Systems Based on the Spine Structure. *Adv. Environ. Biol.*, 8(13), 1324-1337, 2014

### INTRODUCTION

*The process of the advent and development of bionic architecture:*

Biomimetics in Architecture is an emerging field that is currently being defined and explored. The application of observations made in nature to architecture has always been a challenge for architects and designers [1].

Bionics which is also known as Biometrics or creative life engineering is the application of systems biological methods of the nature in engineering systems and modern technologies[2].

Bionics which means "similar to life" is derived from a Greek word "Bion" which means life unit. Some others consider it as a combination of the words Biology and Electronics. Bionics was first introduced in the 1950s. Afterwards, since this word has a medical connotation, researchers working in other fields used biomimicry and biomimetic terms as well? These two terms are mostly used in engineering researches while bionic is used in biological researches.

Although it can be said that all human engineering is a kind of modeling from natural models consciously or unconsciously, this science as a conscious modeling does not have a long history [2].

Bionic architecture or the science of studying the living creatures' life system has been introduced as one of the three world's supreme sciences (Bionics, Nano, IT). Enlivening buildings is one of the tendencies in bionic architecture. It is a supreme belief that complete coordination or harmony with the nature is created [3].

Inspiration from nature in architecture has existed at all times. The first human dwellings were natural shelters, and archetypes such as caves and trees have been used as models for architectural design throughout

**Corresponding Author:** Neda Salsabili, MA in Architectural Technology, School of Architecture, College of Fine Arts, Tehran, Iran.

the history [4]. By the quirk of fate, all architects who have been interested in the nature have achieved valuable scientific and theoretical successes.

Leonardo Da Vinci, the Renaissance's genius, was one of the first ones who integrated "biologic" and "technological" sciences of his own age in order to build his flying machine and sought the living creatures' structure for solving technical problems of his time.

Charlie Luxton, the pioneer of bionic architecture arena, considers appropriate and proper applications of cases in the nature as the focus of bionic architects which causes buildings and structures' strength and resistance and creates variety and serenity in the atmosphere.

Paul Klee believed that we should imitate the forces that have made the world like a child who imitates us in playing games.

Tadao Ando considered the creation of a construction as a part of the nature. He considered architectural figures and configurations as trees, cliffs, mountains, and hills and sought the renovation and reconstruction of the nature in his creativity process and had a penchant for it.

Frank Lloyd Wright, the founder of organic architecture, incorporated his buildings with the nature from the very beginning. He performed that so skillfully and expertly that it was hard to distinguish where the nature ends and when construction begins.

Le Corbusier had a new look at the nature as well. He made a medium between inside architecture and outside nature and by designing Villa Savoye in Poissy, France and building a wide terrace and placing empty frames in its front [5].

Dr. Fissure asserted that today's world is dynamic, so the space we live in should be dynamic too based on our needs that constantly change. If, considering our designing ideas and our mood, buildings and constructions conform to the nature's tune, their shapes and directions change according to the shift from spring to winter, and from sunrise to sunset and are adjusted to the weather, they will revive [6].

#### *The aim of designing based on bionic architecture:*

Imitating and simulating the nature has a lot of advantages. Suppose that every present living creature has evolved since around 3.8 milliard years ago in the transition of the Earth's evolution. In this period of time, the nature has destroyed and eradicated anything that was not compatible with its specific goal. This makes human hopeful to be able to make copies or duplicates of new mechanisms of technology based on living creatures by studying evolution process [7].

#### *The procedure of designing based on bionic designing:*

There are some important factors that exist in the nature and humans have utilized them for the construction of buildings including: 1- covering or crust, 2- structure, 3- grooming or decorating, 4- energy.

Bionics includes 3 parts:

- 1-The science of systems who's functioning is taken from living systems (in structure and the main system)
- 2-the science of systems which have features similar to the features of living systems (mechanisms and functional elements)
- 3-the science of systems that their appearance is similar to living systems (intuitive sensational perceptions from the view point of form)

In fact each product has 3 main elements: structure, mechanism, and form.

In general, the designing procedure based on bionics can be stated as follows:

1-Selecting a living creature (the given phenomenon in the nature):

- humans
- animals
- plants
- diatoms, single cells

2-Identifying biological features: life environment, environmental conditions, temperature, humidity, pressure and sound

- Reactions: vital resources, respiratory systems, food

- Physical characteristics: coexistence conditions, compatibility and incompatibility both direct and indirect

- Systematic relationships: the concentration and distribution of bio-statistics, the special geographical conditions

3 - Identifying the architectural characteristics

- The internal structures

- Systematic relationships

- The main body of the creature: micro elements and geometric proportions, macro elements, materials and proportions [6].

*Negligence in the role of structure in bionic architecture:*



**Fig. 1:**



**Fig. 2:**



**Fig. 3:**



**Fig. 4:**

What can be seen today in the architecture demonstrates that reconciliation with nature has only enjoyed the form (such as Turning torso Calatrava tower (Figure 1) and Kurokawa football stadium (Figure 2) or in some samples mechanisms are applied (such as the movable bridges in Chicago (Figure 3) and Ontario (Figure 4). There are few architectural samples that have applied structure while there has been great attention to structure in other sciences and this shows architectures' negligence in recognizing the body structure of living creatures.

Studying the present designs based on human body shows that imitation of nature and other living creatures is more based on human body's shape and form (such as bionic tower and milwaukee museum) rather than its system and structure. But it can be seen that widespread studies both anatomically and mechanically on human body are more than studies on other organisms and living creatures. On the first sight, it may be assumed that human's body is very complicated, but by studying it we realize that it has a very comprehensible and applicable structure contrary to our assumption. On the other hand, it has an immense variety in its structure and it is possible to create very different and even conflicting results by changing one of its structures.

In the present study, it is attempted to explain the spine as one of the human body's systems and to show that the structure of the spine which seems very complicated and is always trying to keep its balance in all situations can be applied easily and many diverse systems can be created.

#### *The Spine, a considerable structural bionic architecture:*

In the human skeleton (Figure 5), there is a central pillar called the vertebral column or spine. The relationship between structure and function in the human body is portrayed clearly in the study of the spine. The design of structural elements and joints allows the spine to be able to perform various actions. The spine can be the basis or stand for protecting head and the internal organs, a stable base for connecting ligaments, bones, muscles, organs, chest, and pelvis. It connects the upper and lower extremities, and provides body mobility. In addition, the spine protects the spinal cord. By features that were mentioned about the spine, we can see that the spine itself has diverse roles including protection of limbs or organs, mobility and displacement associated with maintaining balance in all body positions, a stable base in order to connect other parts of the body to itself, and even a model to design both static and dynamic structures. These are the results of all features that the spine makes them available for us. Some of these actions require stability while some others require mobility. Thus, the structure which can provide both of these needs should be an integrated or combinational structure. As a result, for an optimum application of the spine, we study the structure of the spine based on its inter-vertebral structure to use them for designing [8].



**Fig. 5:**

#### *Structural designing based on the spine:*

Since considering the inter-vertebral structure and the functioning of vertebrae is one of the fundamental principles of designing based on structure in bionic architecture, the need for recognizing vertebrae and the effect of each on the inter-vertebral structure is highly required.

For a general and detailed recognition of the inter-vertebral structure and the inter-vertebral relationship, a vast study was carried out on vertebrae and then a structural model applicable to structural systems was proposed by analyzing inter-vertebral structure.

#### *Designing based on inter-vertebral structure:*

By studying the inter-vertebral structure of the spine, we came to the conclusion that the main structure of the spine is composed of the appropriate combination of inter-vertebral bones in joints. In order to get familiar with this structure, we must inevitably get familiar with inter-vertebral joints.

#### *1- The joints of the spine:*

A joint is a place where two bones are connected to each other. These connections of joints in the spine are of two types:

1-Cartilaginous joints, the flat type between the vertebral bodies (interstitial discs)

2- Movable joints between the outer surfaces of the articular process of two adjacent vertebrae (facet)

All the joints except the joint between the first two vertebrae of the neck are flat moveable joints. Generally, the movement between two vertebrae is very limited and only includes sliding, transmittance, and rotation. According to White and Panjabi, a vertebra relative to the adjacent vertebrae can move from six directions (three transmittance and three rotations) around three axes (Figure 6). The combination of these small movements of rotations and transmittance of some vertebrae produces a wide range of movement in the whole spine. The movements and dynamics of the entire spine may be likened to a joint with three degrees of freedom of movement which includes flexion, extension, lateral flexion and rotation. Therefore, different behaviors of the 6 states of a pair of vertebrae which are more suitable for the designer's needs can be easily provided by changing each of the vertebrae of the spine [8].

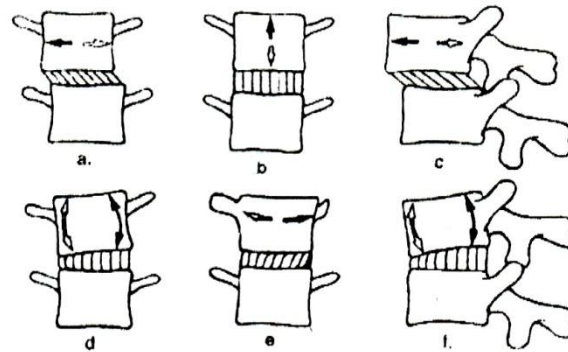

**Fig. 6:**

#### 1.1. Flat joint:

A flat joint between vertebrae is a combination of vertebrae, discs, and ligaments which are explained thoroughly.

#### Vertebrae:

The structure of a vertebra includes two main sections:

- 1-The anterior part which is cylindrical and is called the vertebra body
- 2- The posterior part with an irregular shape and is called the vertebral arch.

The vertebral body is composed of a spongy or trabecular bone which is covered with a layer of cortical bone. According to the results of the studies by Wu and Chen, pressure on the vertebral body is always more in the front (anterior) than the back (posterior). The cortical covering of the upper and lower levels (Planos) around the edges is a thick layer and is covered by a hyaline cartilage layer in the center which is called cartilage final pane and prevents the disc dislocation between vertebrae (Figure 7).



**Fig. 7:**

The vertical, horizontal and inclined trabecular systems which are consistent with the pressures on the vertebral body are found in spongy bone. Vertical systems contribute to body weight bearing and resists against compressive forces. Other trabecular systems are resistant to cutting forces [8].

Diagram 1: The vertebrae of the spine are similar to logo pieces which are fastened together although they have

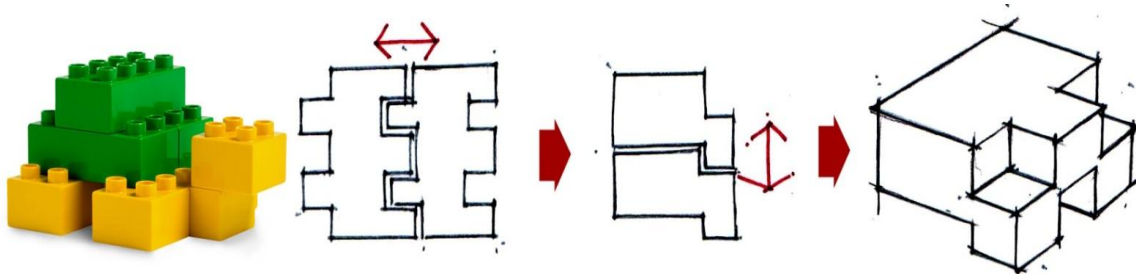
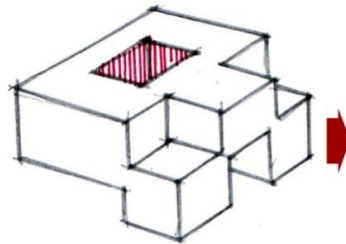

**Fig. 8:**

What was discussed about the structure of a vertebra shows that the vertebrae of the spine are similar to the logo pieces (Figure 8) which are fastened together although they are one module and have similar shapes.



**Fig. 9:**



**Diagram 2:** The vertebrae of the spine have a hollow tube or hole named spinal canal in the middle for the passage of the spinal cord through it.

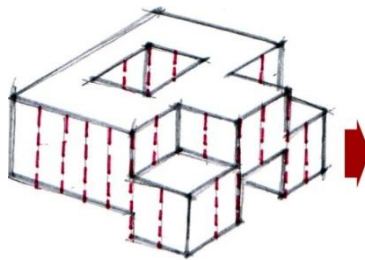

**Diagram 3:** The vertebrae have a trabecular structure surrounding them in order to transfer vertical loads.

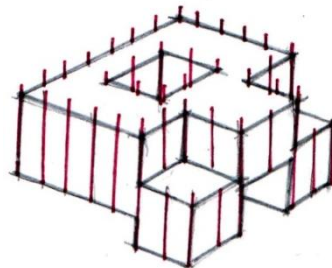

**Diagram 4:** The outer surface of the vertebrae has a transverse process or excrescent piece on the lateral side so that the vertebrae do not go off.

The important point is that trabecular system is similar to the structural systems in that each vertebra of the spine transmits vertical forces to the next vertebra by itself and works against cutting forces as well. Therefore, it is possible to design a vertebra as follows with different kinds of present structural systems (shaft and pillar ...) (Figure 9):

Vertebral arch structure is more complex than the vertebral body because it has many processes (little bony bumps) such as three non-joint processes (ligaments and muscles are attached to them) and four joint processes (facet joints) (Figure 10) [8].

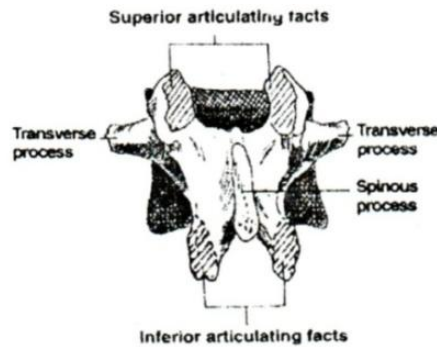

**Fig. 10:**

#### *Inter-vertebral discs:*

Inter-vertebral discs make up about 20% to 33% of the length of the spine and become longer as they come downward from the neck (cervical spine) to the waist (lumbar spine). The disc thickness varies from about 3 mm in the neck to about 9 mm in the lumbar region. Although disc in the lumbar has the largest and in the cervical has the smallest size, the ratio between the thickness of the disc and vertebral body height in the cervical and lumbar spine is the highest and the lowest in the dorsal or thoracic region. Natural differences in disc height conform to with small differences in mechanical functions.

Discs consist of two parts, a central part called the nucleus and a septum or wall called annulus fibers.

The compositions of nucleus and annulus fibers are similar, in the sense that they both have water, collagen and proteoglycans. However, the relative proportion of these materials and types of collagen in the two layers are different. Water and proteoglycans density is the highest in the nucleus and the lowest in the external fibers. On the contrary, the density of collagen fibers in the external annulus fibers is the highest and in the nucleus is the lowest. The system and material properties in the discs lead to the viability of the discs (which have the power of self-reconstruction in case of injury) and their flexibility [8].

#### *Annulus fibers:*

Collagen fibers are arranged in the annulus plates called lamella. Lamellae are concentric rings which generally surround the nucleus. Collagen fibers in the adjacent rings direction to each other is so that they make an angle of 120 degrees. Intermediate filaments of circular or annular fibers are stronger than the filaments of the internal and external annulus fibers and show less strain. The filaments of annulus fibers are connected to cartilaginous endplates which are on upper and lower plates (the outer surface of vertebra) as well as epiphyseal circle (the outer cartilage surface around the outer crust or cortex of vertebra).

#### *The nucleus:*

The nucleus takes force or pressure from the upper vertebra and transmits and spreads it to annulus fibers and its lower vertebra. Longitudinal sections of different parts of the spine show that the nucleus is not exactly in the center of the inter-vertebral disc (Figure 11).

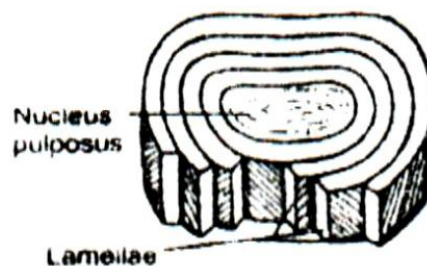

**Fig. 11:**

In the neck or cervical spine, it is located exactly on the movement axis.

In the thoracic spine, it is behind the movement axis.

In the lumbar region, it is located exactly on the movement axis. Leonardi says that the core of the nucleus is located by an equal distance from the anterior side of the vertebra and yellow ligament is and clearly defines an equivalence center.

When a compressive force is exerted, 75% of it is exerted to the nucleus and 25% of it to the annular fibers. Meanwhile, the pressure in the core of the nucleus is never zero even when no force is exerted on the disk. This pressure is the result of water absorption which is due to the inflammation of the disc in its rigid inflexible lining. This is similar to the pre-pressure situation which in inter-vertebral disc increases resistance against compressive forces and lateral bending forces which result in the elasticity of the disc similar to what exists in the structural behavior of pre-stressed concrete.

In general, what is observed in the behavior of inter-vertebral discs is similar to what is seen in the behavior of intercity trains (Figure 13) or wagons or double-decker buses (Figure 12) which have air mattresses that are responsible for transmitting pressure to adjacent carriages. Therefore, this system can be easily simulated by considering an air (Figure 14) or silicon mattress which has elasticity and can transmit pressure from one module to another and can distribute it in a surface and sometimes if needed it can be repaired or injected or optimized. In order to distribute the load or pressure on surface, a transition structure system must be used beneath and above the mattress.

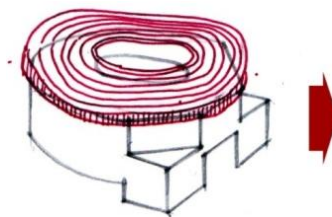

**Fig. 13:**



**Fig. 14:**

Hence, for better load transfer, the structure must have better adaptability and correspondence with the disc in it so that it spreads the load more uniformly. On one hand, since the most pressure is transmitted from one vertebra to another by the nucleus, and on the other hand, the annulus fibers transmit pressure from the nucleus, a nucleus can be utilized.

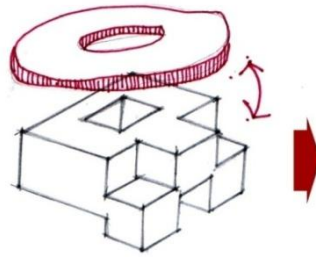

**Diagram 5:** There is a disc between the vertebrae of the spine which transfers load from one vertebra to another.

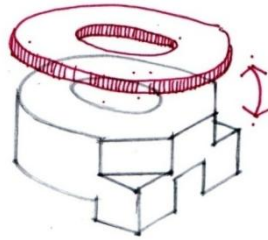

**Diagram 6:** The shape of vertebrae and the disc between them correspond to each other so that transmission of pressure and load is done uniformly and perfectly.





**Diagram 7:** The discs consist of a series of concentric annulus rings and a nucleus in the middle and rings transmit loads and pressures to the nucleus.



**Diagram 8:** It is the nucleus which has the main task of transferring loads, therefore, all concentric annulus rings and the nucleus can be considered as one.

#### 1-2- Facet joints:

Facet joints are joints between the left and right joint facets of the lower vertebra and the left and right joint facets of the upper vertebra and are four flat moveable joint facets (Figure 15). Ligaments of facet joints play an important role in resisting against the flexion of inter-vertebral joints and these joints protect inter-vertebral discs against cutting forces [8].

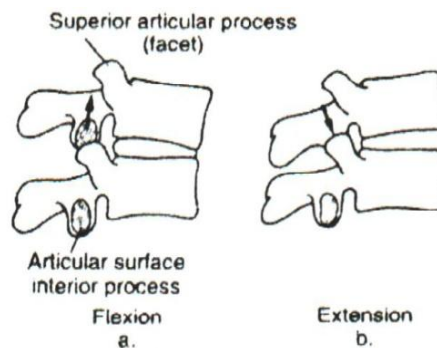

**Fig. 15:**

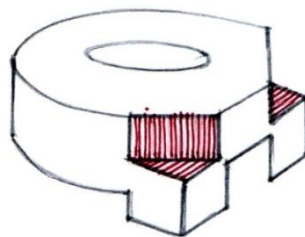
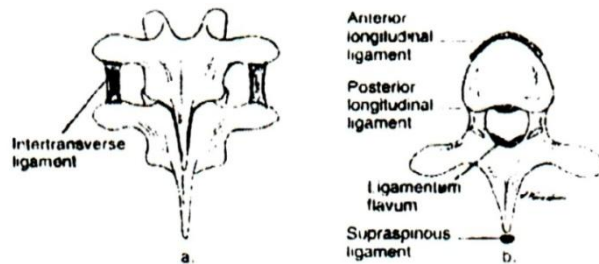

**Diagram 9:** The vertebrae have a series of inter-vertebral facet joints whose work is to protect the spine against cutting forces.

This way, joints are similar to excrescences and dents of logo beads which cause modules not to rotate on each other.

## 2- Ligaments and the inter-joint capsules:

There are six major ligaments working with inter-vertebral joints and facets which include anterior longitudinal ligaments, the posterior longitudinal ligaments, ligamentum flavum, inter-spinous ligaments, inter-transverse ligaments, and supraspinous ligaments (Figure 16).



**Fig. 16:**

Ligaments only work in stretches or tensions based on the behavior they show and behave exactly like tension cables that only work in tensions and stretches (Figure 17).



**Fig. 17:**

### *The anterior longitudinal ligament:*

These anterior fibers strengthen the spinal vertebrae and discs and inter-vertebral joints. This ligament is compressed in flexion and is extended or stretched and has twice the power of the posterior longitudinal ligament.

### *Posterior longitudinal ligament:*

Anterior longitudinal ligament is located on the opposite side of the anterior longitudinal ligament. This ligament is stretched in flexion and has the highest strain and is loosened in extension.

These two types of ligaments have two layers. The first layer is long surface fibers and joins multiple vertebrae and the other layer are short inter-vertebra fibers that only join two vertebrae.

### *Ligamentum Flavum:*

This is a thick and elastic ligament that is located posterior to the spinal canal which is drawn from the second cervical vertebra to the sacrum and is connected to the lamina blade of adjacent vertebrae. Although the maximum strain in this ligament is during flexion, it is under constant tension even in a neutral state.

### *Interspinous ligaments:*

These ligaments stick to the edge of the adjacent spinous processes and cover them. These ligaments are loose during extension and in anterior flexion resist by the distancing the spinous process when bending forward occurs. So, it has less potential power against tension or strain than the anterior longitudinal, the posterior longitudinal ligaments, and ligamentum flavum.

### *Supraspinous ligaments:*

This ligament connects the tips of spinous processes. This ligament is stretched in flexion and is sharply stretched in bending forward.

### *Intertransverse ligaments:*

This ligament is pulled from one side and is pressed from the other side during lateral flexion.

By studying ligaments we come to the conclusion that ligaments in four sides of the spine are located in different places according the degree of strain and pressure to prevent dislocation of vertebrae and discs when they are under pressure and strain and it is only inter-traverse ligaments which play a role in lateral pressures and strains.

Ligaments' stretch creates a constant pressure on the disc which causes the pressure to remain high inside the discs which supports the spine in a neutral state and makes them more powerful [9].

In fact, ligaments are like the string of prayer beads connecting the beads and are always under pressure (Figure 18).



**Fig. 18:**

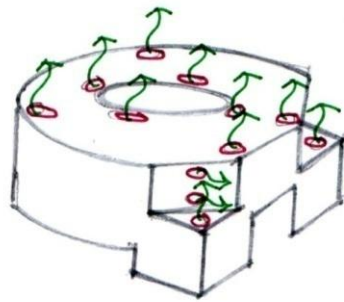

**Diagram 10:** The vertebrae are connected to each other by a series of ligaments to show an integral behavior.

The maximum amount of compressive forces is tolerated by the discs and vertebral bodies and vertebral arch and facet joints bear some forces in a given situation or particular movement.

Given the ligaments' behavior, it can be utilized easily as a structural element by cables like what we have in cable structures [9].

### 3- Muscles:

Many muscles contribute to stability and mobility in the spine. The easiest way for categorizing vertebral muscles is categorizing them based on their performance. They include front flexor muscles, side flexor bending muscles, rotator muscles, and erector muscles.

Generally, flexor muscles are in the anterior and extensor muscles are located in the posterior and flexor and rotating muscles are on both sides of the spine.

Considering what was mentioned about muscles, muscles function like an engine (Figure 19) which alters the shape and state of vertebrae. By placing each of them, it is possible to make a structure moveable in all directions. This depends on whether we want to have a moveable dynamic or fixed stable structure [10].



**Fig. 19:**

*Conclusion:*

The spine which is the biggest and most important structure of the human body system has a simple structure, yet its functioning is very diverse and complex. Despite the behaviors and displacements in all directions, its structure would not collapse and is always trying to keep its center of gravity. It is possible to create very versatile structures with different capabilities by simulating and changing it which has been neglected by designers and architects so far.

The spine consists of some main levels that include 1 - joints (vertebrae, discs) 2 – ligaments, and 3- muscles which are separately made in different sciences and different designs and they are only required to be combined together in a more integrated way.

In summary, vertebrae which include the two static and dynamic parts transmit pressures or loads by a trabecular system and play an integrated role with a behavior similar to those of present architectural structures and are used in a variety of structures and buildings. Discs which consist of nucleus and annulus fibers are like air or silicone mattresses that their task is to transfer the load from one vertebra to another. Vertebral ligaments are like cables that hold vertebrae together in different directions. They only have a tensile role and prevent the dislocation of the vertebrae from their place. Muscles are like messaging engines which move and displace the whole structure in different directions.

By recognizing the spine and its curves, it is possible to simulate different forms and states of human body (lying, sitting, jumping, bending, etc.) at different ages (infancy, childhood, youth , aging, weight lifting, field and tracks, etc.) with different curves.

The spine is only a part of the human skeleton and there are also a variety of other capabilities in the human body, each of them can be used for the construction of variant structural systems which have been neglected. If we want to mention the patterns of the human body that have been used for designing, all of them have been used as models of form and mechanism and designers have only paid attention to its geometry. It is the human which is considered as the supreme creature and there are a lot of studies carried out on individual parts of human body on its anatomy and its mechanical behavior in comparison to other organisms which have been neglected and this neglect just goes to architects and structural engineers because applications of living creatures is frequently seen in other sciences.

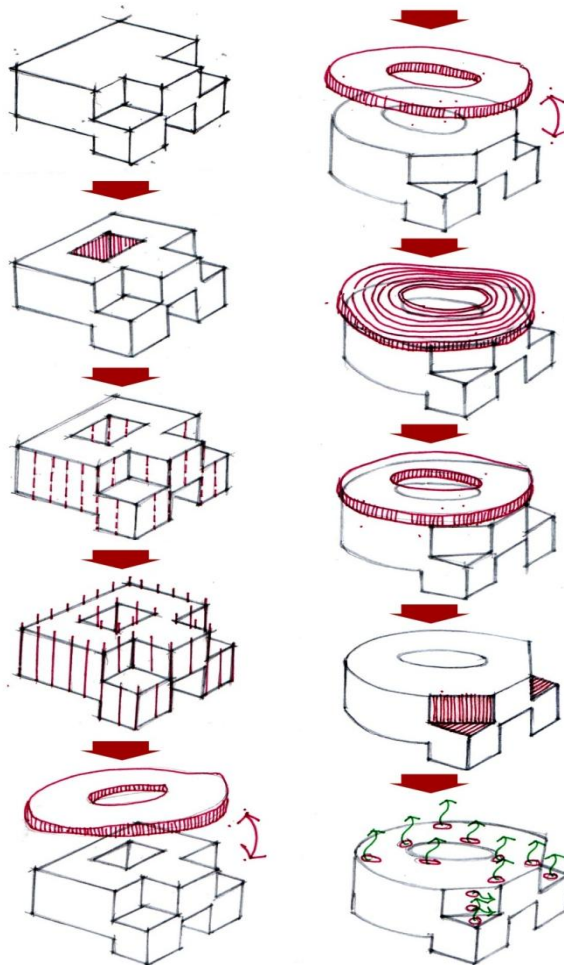

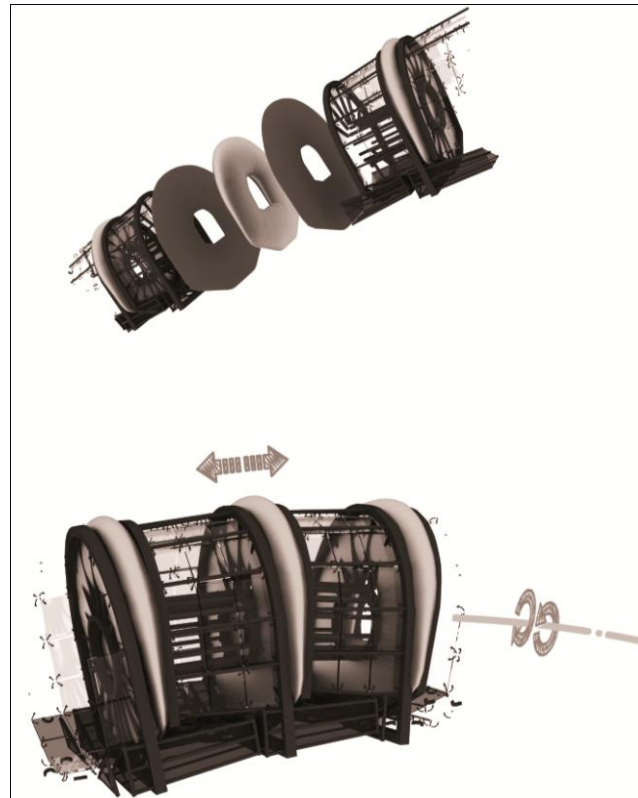

The shape of vertebrae and the disc between them correspond to each other so that transmission of pressure and load is done uniformly and perfectly.

The discs consist of a series of concentric annulus rings and a nucleus in the middle and rings transmit loads and pressures to the nucleus.

It is the nucleus which has the main task of transferring loads, therefore, all concentric annulus rings and the nucleus can be considered as one.

The vertebrae have a series of inter-vertebral facet joints whose work is to protect the spine against cutting forces.

The vertebrae are connected to each other by a series of ligaments to show an integral behavior.

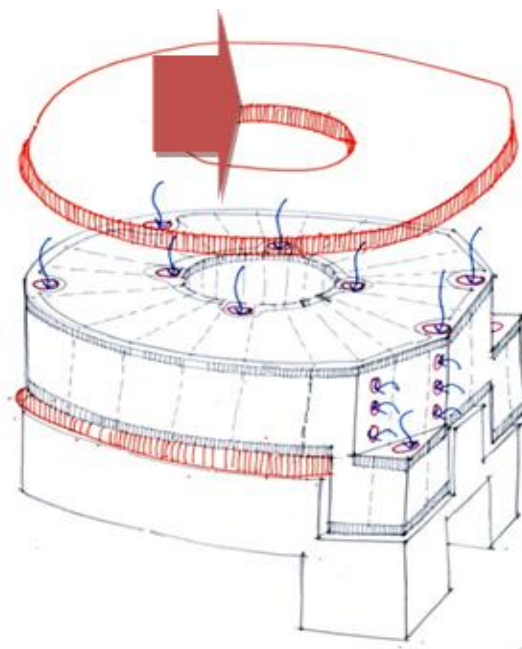

**Diagram 11:** In general, the inter-vertebral structure of the spine can be simulated as above.

**REFERENCES**

- [1] Petra, G., 2011. *Biomimetics - Materials, Structures and Processes: Examples, Ideas and Case Studies*.
- [2] <http://hamshahrionline.ir/print/76292>, 2009
- [3] <http://fa.wikipedia.org/wiki/>
- [4] Portoghesi, P., 2000. *Nature and Architecture* (Skira editore, Milan, 2000)
- [5] Ahmadi Shelmani, M.H., 2010. Top Projects of Bionic Structure.
- [6] Ahmadi Shelmani, M.H., 2010. Introduction to Architectural Bionic.
- [7] Ahmadi Shelmani, M.H., 2010. Contemporary Architectural Bionic.
- [8] Elahi, B., 1992. *Anatomy of the Upper Limb, Lower Limb and Joint*.
- [9] Karimi, H., Gh. Talebi, R. Ghalamghash. 2004. *Biomechanics and Kinsiology of the Upper Limb*.
- [10] Sokhangooyi, Y., M. Akbari, A. Najafi, 2004. *Biomechanics of the Spine and Rid Cage*, (University of Walfare and Rehabilitation Sciences).